



MAX3799 Evaluation Kit

General Description

The MAX3799 evaluation kit (EV kit) is an assembled electrical demonstration board that provides easy computer-controlled evaluation of the MAX3799 multirate limiting amplifier and VCSEL driver. The included software communicates with the EV kit through the USB port, and provides access to all the internal registers to optimize the functionality of the MAX3799. The EV kit is powered by a +3.3V supply and USB port. SMA connectors are used for the high-speed inputs and outputs. An LED indicates the status of USB power.

Features

- ◆ Fully Assembled and Tested
- ◆ Software Control Through USB Port
- ◆ SMA Connectors for High-Speed Inputs and Outputs
- ◆ Powered by +3.3V Supply and USB Port
- ◆ Indicator for USB Power

Ordering Information

PART	TYPE
MAX3799EVKIT	EV Kit

Component List

DESIGNATION	QTY	DESCRIPTION
C3–C6, C11, C12, C50, C51	8	0.01 μ F \pm 10% ceramic capacitors (0402)
C7, C9, C10, C14, C15, C16, C19, C43, C44, C45, C47, C53	12	1000pF \pm 10% ceramic capacitors (0402)
C18, C22	2	33pF \pm 5% ceramic capacitors (0402)
C21	1	0.1 μ F \pm 10% ceramic capacitor (0805)
C25–C28, C46, C48, C49, C52, C56	9	0.1 μ F \pm 10% ceramic capacitors (0402)
C29	1	0.1 μ F \pm 10% ceramic capacitor (0603)
C34, C55	2	1 μ F \pm 10% ceramic capacitors (0603)
C35, C37, C38	3	4.7 μ F \pm 10% ceramic capacitors (0805)
C57	1	22 μ F \pm 5% tantalum capacitor (B case)
D6	1	Green LED Lumex SSL-LX3044GD
J1, J2, J4–J9	8	SMA connectors, edge mount, tab center Johnson 142-0701-851

DESIGNATION	QTY	DESCRIPTION
J3	1	Mini USB connector, B type Tyco 1743035-1
JU1–JU9, JU20	10	2-pin headers, 0.1in centers
L4	1	4.7 μ H \pm 20%, 870mA inductor Taiyo Yuden CBC3225T4R7MR
L8, L9, L11	3	Ferrite beads (0603) Taiyo Yuden FBMH1608HM102-T
L13	1	22 μ H \pm 20% inductor, 520mA Taiyo Yuden CBC3225T220M
R1	1	1k Ω \pm 1% resistor (0402)
R2	1	Not installed
R10, R16, R50	3	4.7k Ω \pm 1% resistors (0402)
R18, R25, R29, R52, R55, R62, R66, R73	8	499 Ω \pm 1% resistors (0402)
R24	1	1.5k Ω \pm 1% resistor (0402)
R30, R31, R48, R51, R53	5	10k Ω \pm 1% resistors (0402)
R91	1	680 Ω \pm 5% resistor (0402)
TP1, TP3, TP6, TP7, TP9, TP10, TP11, TP13, TP14, TP15, J10, J13	12	Test points
U8	1	Multirate limiting amplifier and VCSEL driver Maxim MAX3799ETJ+ (32 TQFN-EP*)

Evaluates: MAX3799

MAX3799 Evaluation Kit

Component List (continued)

DESIGNATION	QTY	DESCRIPTION
U10	1	Microcontroller (28 SO) Microchip PIC16C745-I/SO
Y1	1	6.000MHz, 32pF SMD crystal ECS-60-32-5PXD-N-TR

DESIGNATION	QTY	DESCRIPTION
—	10	Shunts
—	1	PCB: MAX3799 EVALUATION BOARD+, REV A

+Denotes a lead(Pb)-free/RoHS-compliant package.

*EP = Exposed pad.

Quick Start

Note: In the following sections, software-related items are identified by bolding. Text in **bold** refers to items directly from the EV kit software. Text in **bold and underlined** refers to items from the Windows® operating system.

- 1) Install shunts on jumpers JU1 through JU7.
- 2) Connect a +3.3V supply to VCC (+3.3V) (J13) and GND (J10). Set the supply current limit to 300mA.
- 3) Connect the computer to the EV kit with a USB cable (A-male to mini-B-male). LED D6 should switch on, indicating that USB power is detected.
- 4) Connect a 2.0V power source to BIAS (TP3) to ensure proper transmitter operation.
- 5) To download the latest version of the EV kit software (MAX3799revX.zip), visit the Maxim website at www.maxim-ic.com/evkitsoftware. Uncompress the zip file to a local folder and run the installation file (setup.exe). Installation requires administrative rights and can also require Internet access to download necessary drivers.
- 6) After installation is complete, follow this path to start the program: **Start** → **All Programs** → **Maxim Integrated Products** → **MAX3799 Evaluation Kit**.
- 7) If the MAX3799 EV kit is connected with a USB cable, the Status indicator turns green. Otherwise, double-check the USB connection.
- 8) The receiver (Figure 1) and transmitter (Figure 2) are controlled on separate tabs. The registers contain a default setting and can be read using the **Read All** button. For detailed register functions, refer to the MAX3799 IC data sheet.
- 9) Connect a 50Ω CML source to RIN± (J4 and J9) for the receiver. Connect a 50Ω CML source to TIN± (J5 and J6). Set the input amplitude to 400mVp-p.
- 10) Connect a 50Ω terminated oscilloscope to ROUT± (J7 and J8) and to TOUT± (J1 and J2). The receiver output amplitude can be adjusted with the **CML output level** control. The transmitter output amplitude can be adjusted with the **IMod** control.

Windows is a registered trademark of Microsoft Corp.

MAX3799 Evaluation Kit

Evaluates: MAX3799

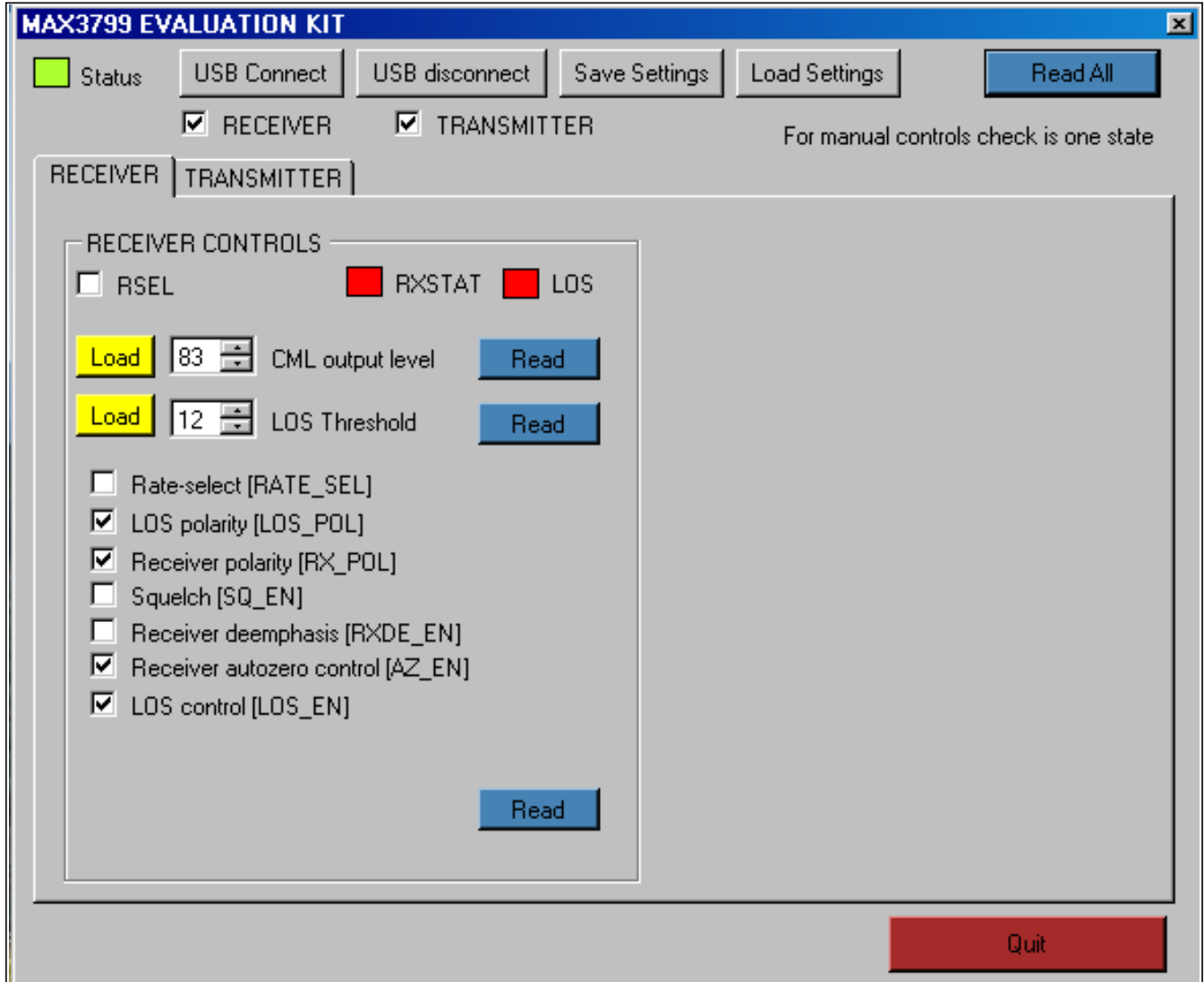

Figure 1. MAX3799 EV Kit Software (Receiver)

MAX3799 Evaluation Kit

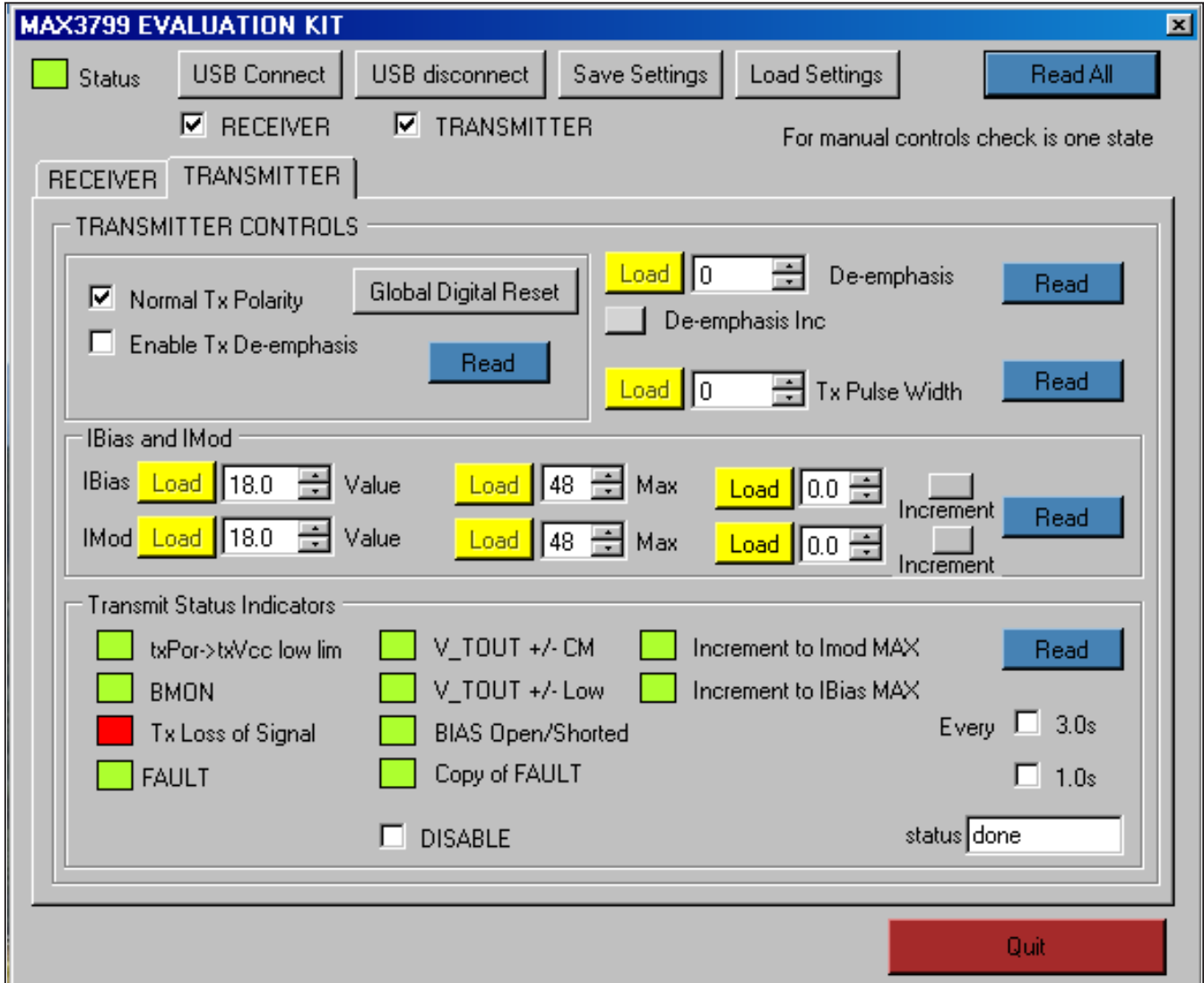

Figure 2. MAX3799 EV Kit Software (Transmitter)

MAX3799 Evaluation Kit

Evaluates: MAX3799

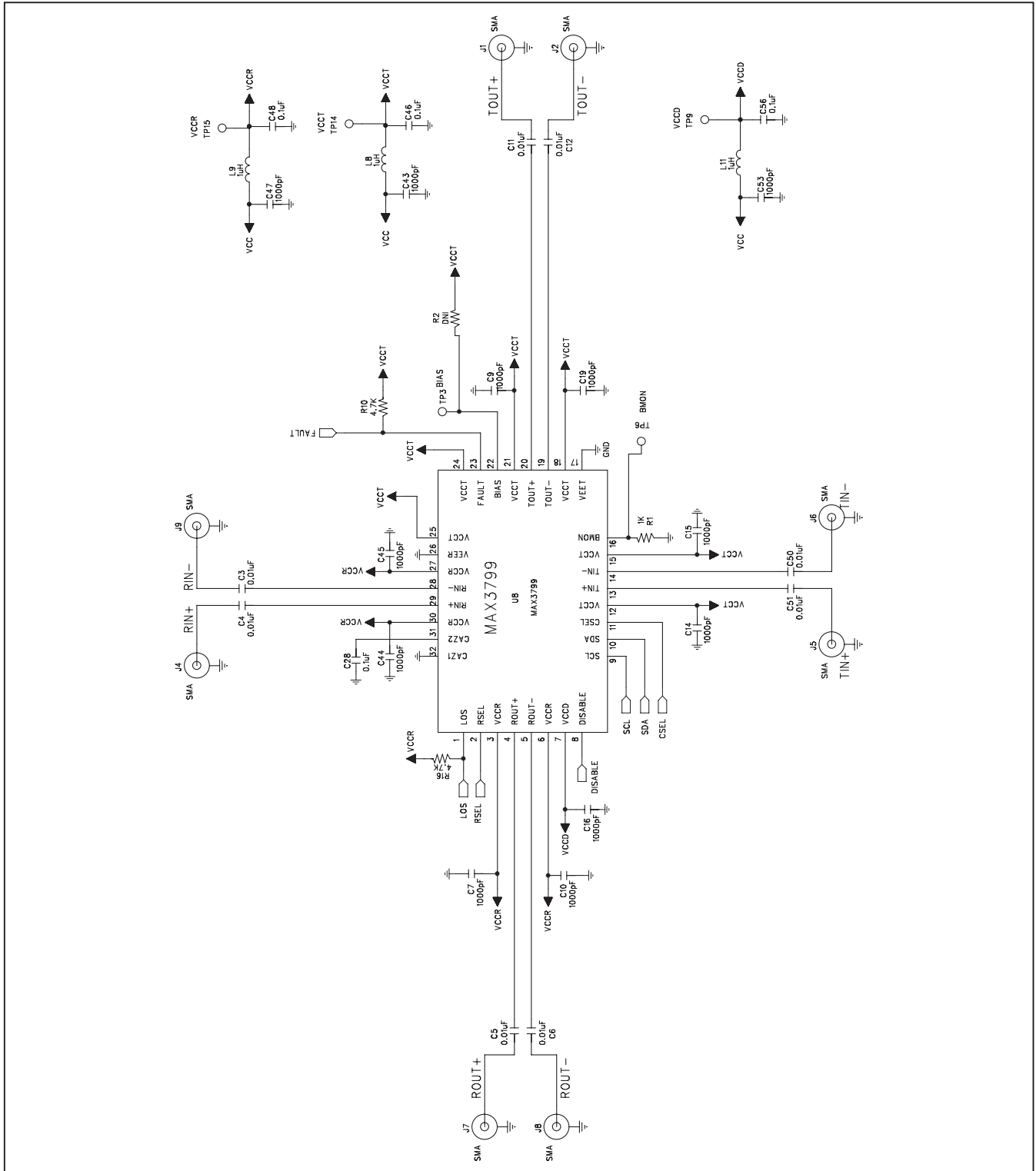

Figure 3a. MAX3799 EV Kit Schematic (Sheet 1 of 2)

MAX3799 Evaluation Kit

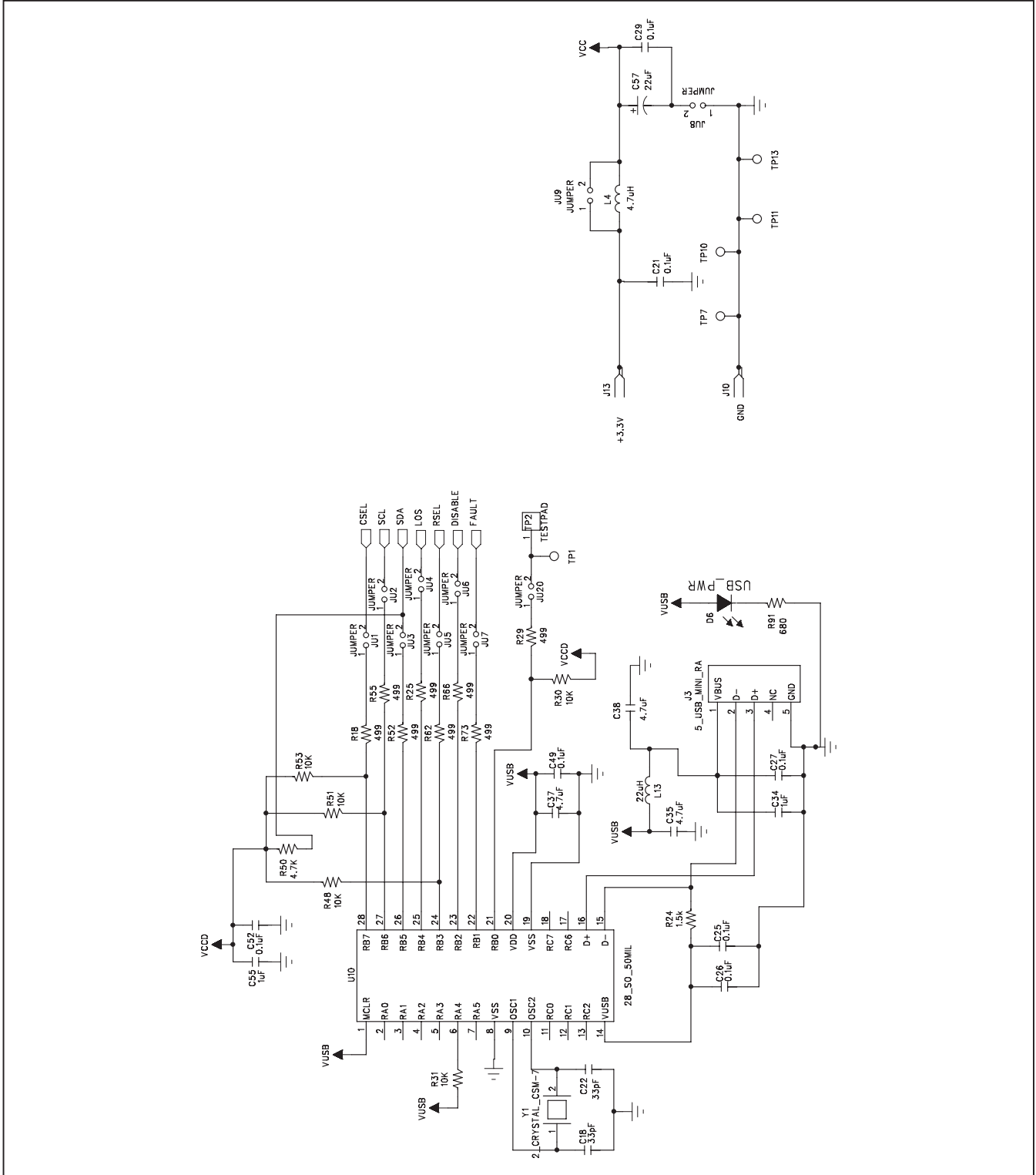

Figure 3b. MAX3799 EV Kit Schematic (Sheet 2 of 2)

MAX3799 Evaluation Kit

Evaluates: MAX3799

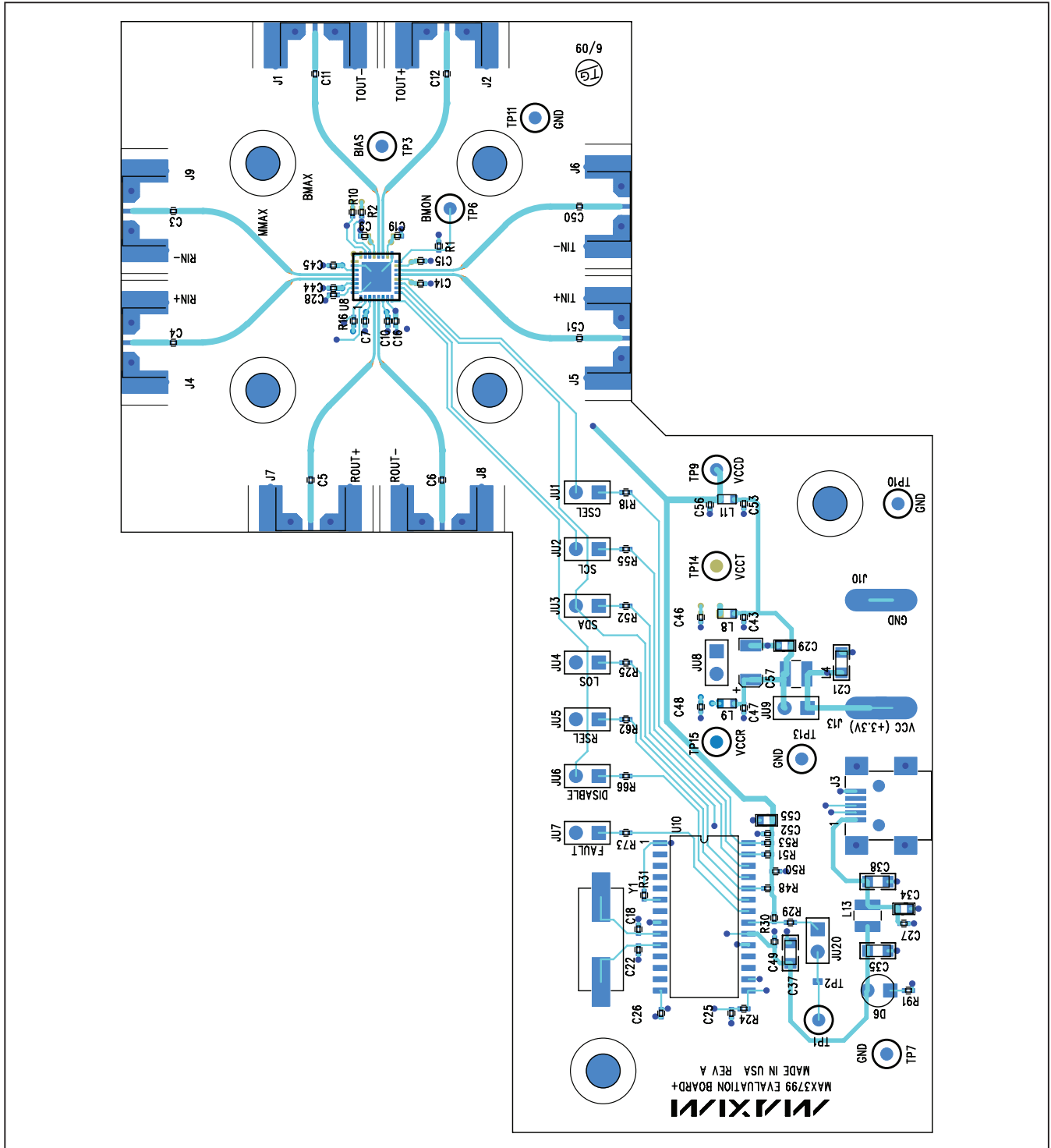

Figure 4. MAX3799 EV Kit Component Placement Guide—Component Side

MAX3799 Evaluation Kit

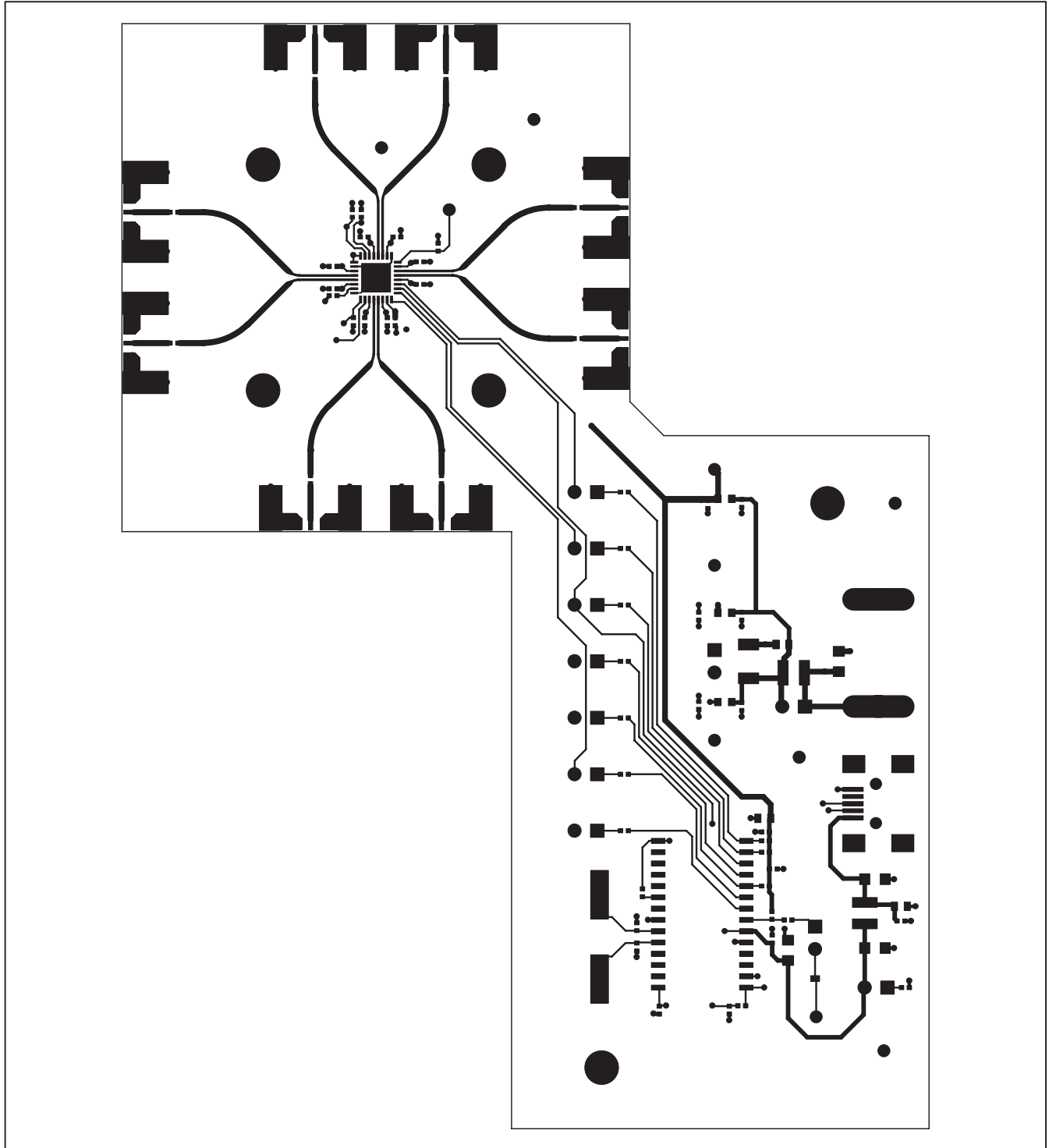

Figure 5. MAX3799 EV Kit PCB Layout—Component Side

MAX3799 Evaluation Kit

Evaluates: MAX3799

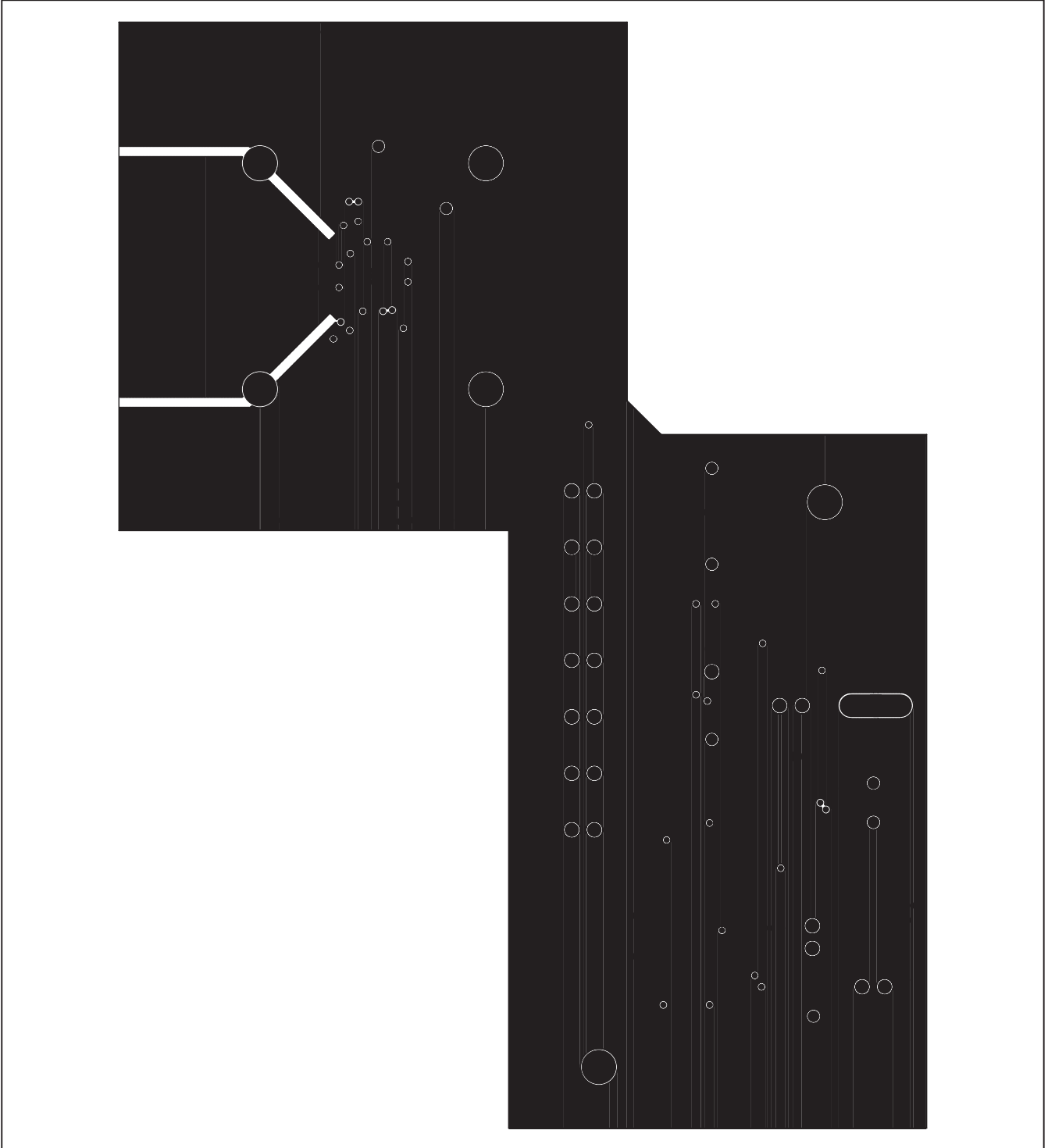

Figure 6. MAX3799 EV Kit PCB Layout—Ground Plane

MAX3799 Evaluation Kit

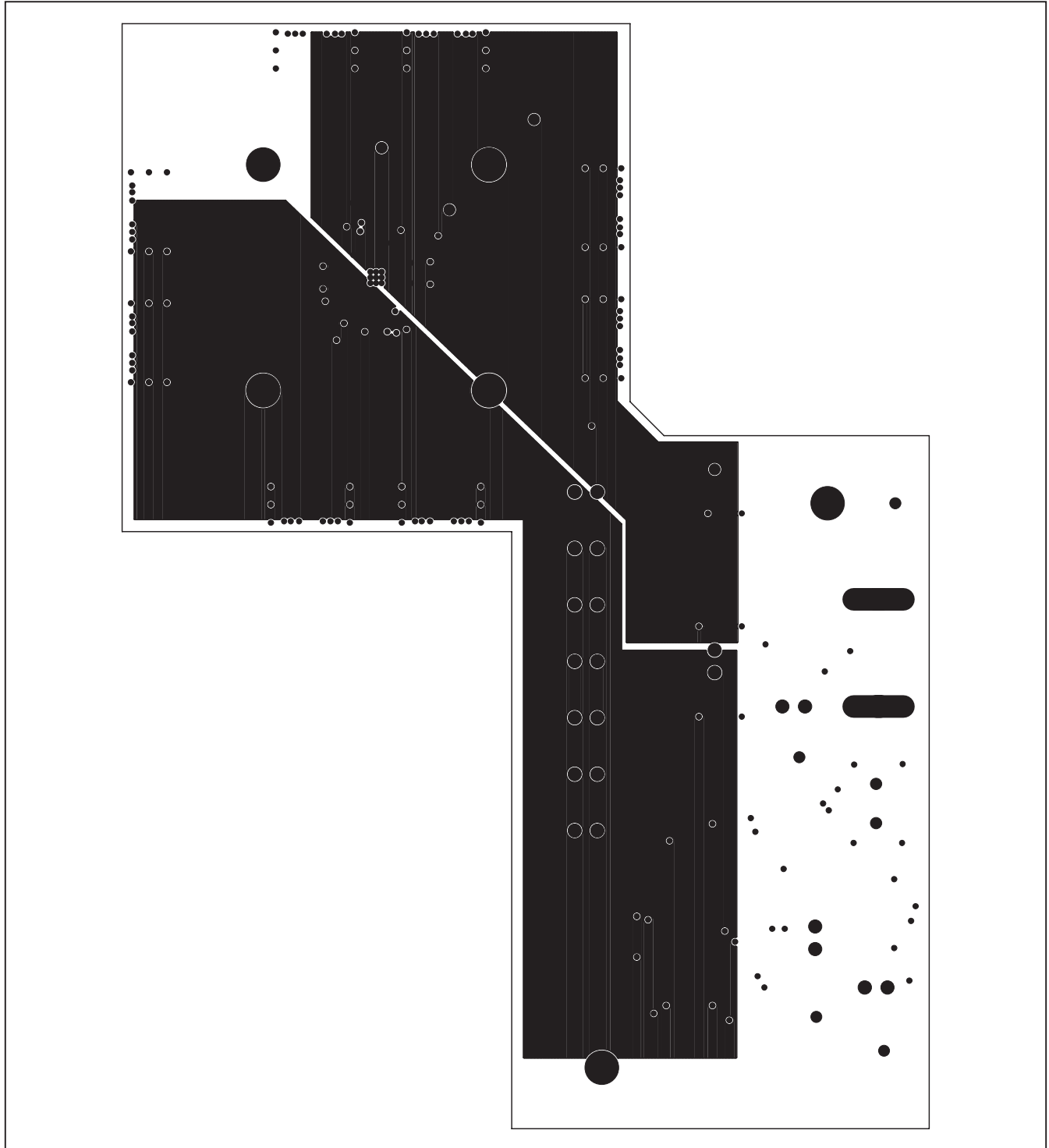

Figure 7. MAX3799 EV Kit PCB Layout—Power Plane

MAX3799 Evaluation Kit

Evaluates: MAX3799

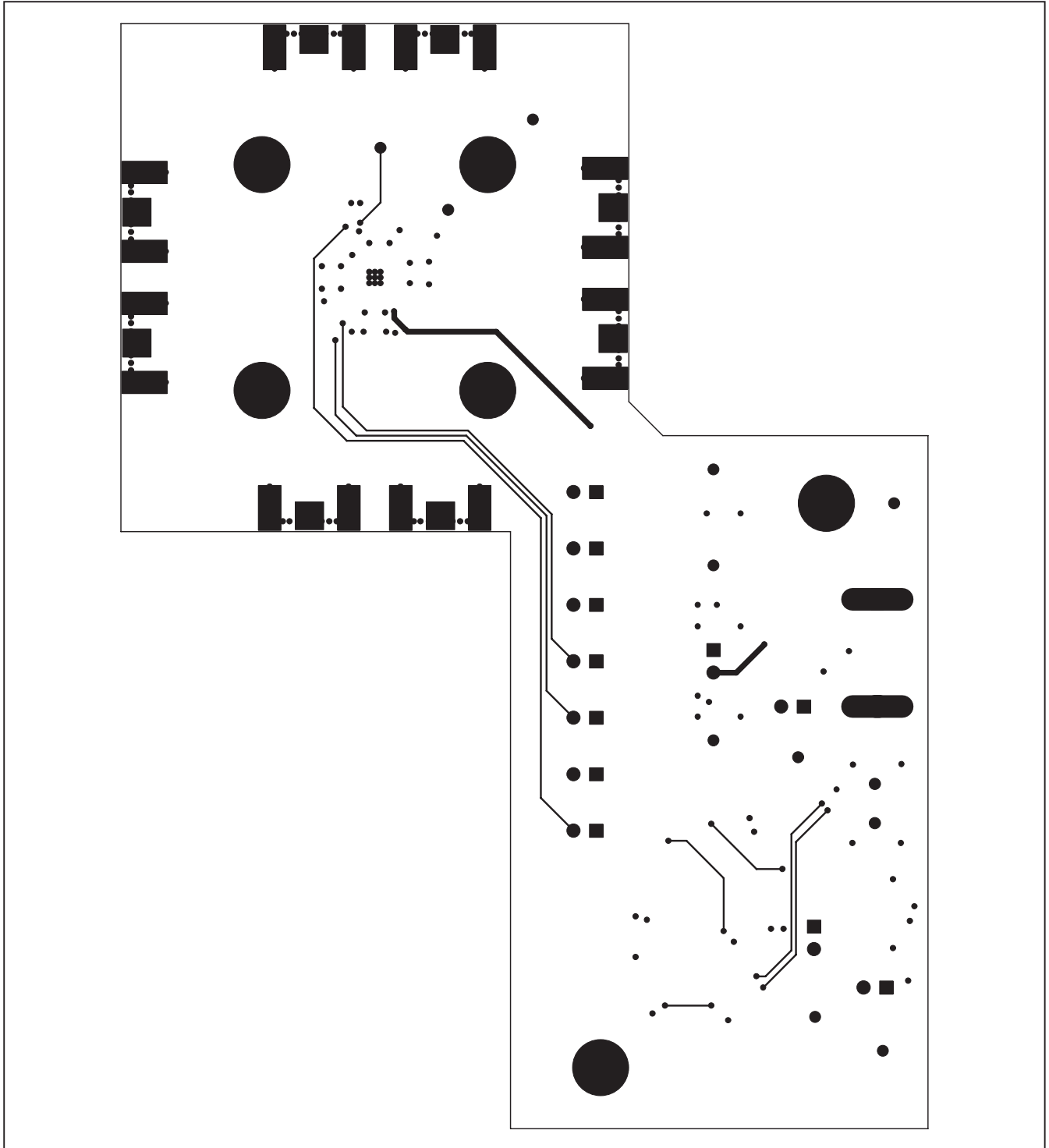

Figure 8. MAX3799 EV Kit PCB Layout—Solder Side

Maxim cannot assume responsibility for use of any circuitry other than circuitry entirely embodied in a Maxim product. No circuit patent licenses are implied. Maxim reserves the right to change the circuitry and specifications without notice at any time.

Maxim Integrated Products, 120 San Gabriel Drive, Sunnyvale, CA 94086 408-737-7600 _____ 11